

**Installation Procedure**  
 (See specific installation sheet for more details)

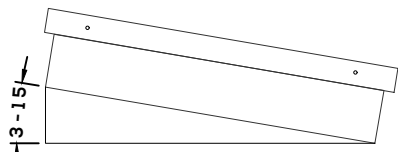

Rooflight must be installed on a roof pitch between 3-15° (by others). Failure to do so will result in water pooling on the rooflight.

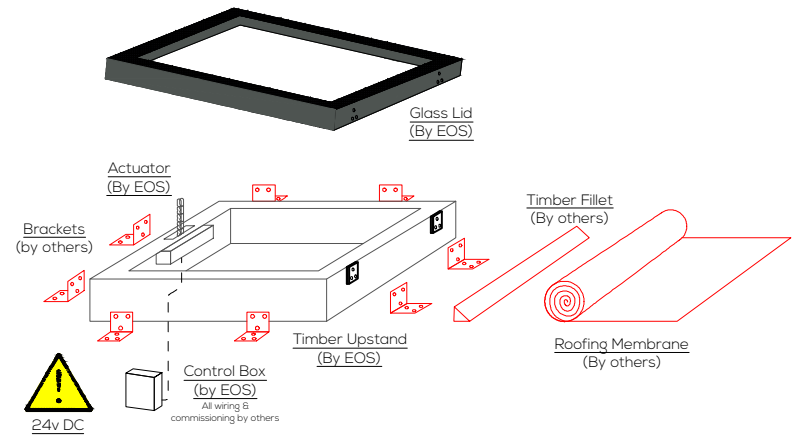

**Title:**  
Eco Double Glazed Electrical Opening Rooflight With Insulated Upstand

<b>System:</b> Eco	<b>Size:</b> 1500mm x 1000mm	<b>Type:</b> Opening	<b>Ref:</b> O3
-----------------------	---------------------------------	-------------------------	-------------------



**Scale:**  
1:4 @ A3

**Date:**  
Jan 21

**revision**  
0

**Key:**  
 — by others  
 — by EOS